



## BX1754

### 2022-2024 Chevy 1500 Silverado (No Limited or ZR2) Installation Instructions

**Attachment Tab Height: 21"**

**Attachment Tab Width: 30"**

**Serial Number**

**Please read BOTH these Installation Instructions and the General Information sheet prior to installing or operating this equipment.**

1. Blue Ox® towing products and accessories are intended to be installed by Blue Ox® Dealers who are familiar with our products and have the equipment and knowledge necessary to do "fit work". If needed, Blue Ox® Dealers can be found at [www.blueox.com](http://www.blueox.com) or by contacting our Technical Service Department at (402) 385-3051.
2. Many Blue Ox® baseplates are designed to use existing holes and hardware to mount the baseplate to the towed vehicle. Even though bolts are there, do not assume they are adequate for baseplate mounting. Always use the hardware supplied in the hardware kit and existing hardware as specified in the installation instructions.



If the front of your vehicle looks different than this, please contact us at (402)385-3051.

**Reference your vehicle owner's manual for manufacturer's towing specifications.**

#### Bolt Torque Specifications

Torque in Foot-Pounds for Inch Bolts

Bolt Size	Grade 5	Grade 8
1/4"	10	14
5/16"	19	29
3/8"	33	47
7/16"	54	78
1/2"	78	119
5/8"	154	230
3/4"	257	380

#### Bolt Torque Specifications

Torque in Foot-Pounds for Metric Bolts

Bolt Size	Grade 8.8	Grade 10.9
6MM	6	8
8MM	16	22
10MM	31	40
12MM	54	70
14MM	89	117
16MM	161	230
18MM	222	318



## WARNING

Failure to read and follow these instructions could result in separation of the towed vehicle from the tow bar, causing property damage, loss of towed vehicle, personal injury or death.

BX1754  
2022-2024 Chevy Silverado 1500 (No Limited or ZR2)  
Installation Instructions

**Instruction Notes:** The fascia cover, handle, grille, fascia, and bumper are removed and reinstalled for the baseplate installation. Tow hooks are removed but are not reinstalled. Some drilling and trimming is required.

Place all components that are removed on a flat, sturdy surface. All items will be reinstalled unless otherwise noted after the baseplate is installed.

The dimensional variations between otherwise identical vehicles can be considerable. While the baseplate was designed for easy installation, it may be necessary to tailor the baseplate slightly to compensate for vehicle manufacturer's tolerances.

The BX8848 Tail Light Wiring Kit is recommended for this vehicle.

## ***NOTICE***

- Handling of some cosmetic parts when installing this product may require the use of protective covers, rags, specialty tools, etc. to prevent damage.
- When using power drills be aware of the dangers of torque and drill bit length.
- When using a reciprocating saw be aware of objects behind the cutting surface.
- Use a good quality paint to spray cut edges of frame to prevent rusting.
- Be sure that **ALL** electrical connections are plugged in and accessories are functioning properly before reinstalling the fascia.
- The baseplate is computer tested to your vehicle's GVWR, exceeding this weight will void the manufacturer's warranty.
- Be sure to use a sufficient amount of Loctite® Red on all bolt threads before tightening. Tighten all bolts according to the torque chart provided unless specified.
- Dealer or installer be certain the user receives these instruction sheets.
- If the baseplate is in an accident, it must be replaced. **DO NOT** use it again! An accident can cause unseen damage and using it again could result in more damage or serious injury. **DO NOT** use the baseplate if it is damaged or missing parts.

# BX1754

## 2022-2024 Chevy Silverado 1500 (No Limited or ZR2)

### Installation Instructions

<b>Tools Required</b>	
Flat Screwdriver	7MM Socket
Torque Wrench	10MM Socket
Drill	15MM Socket
Loctite® RED	15MM Wrench
1/2" Drill Bit	18MM Socket
3/4" Socket	18MM Wrench
3/4" Wrench	

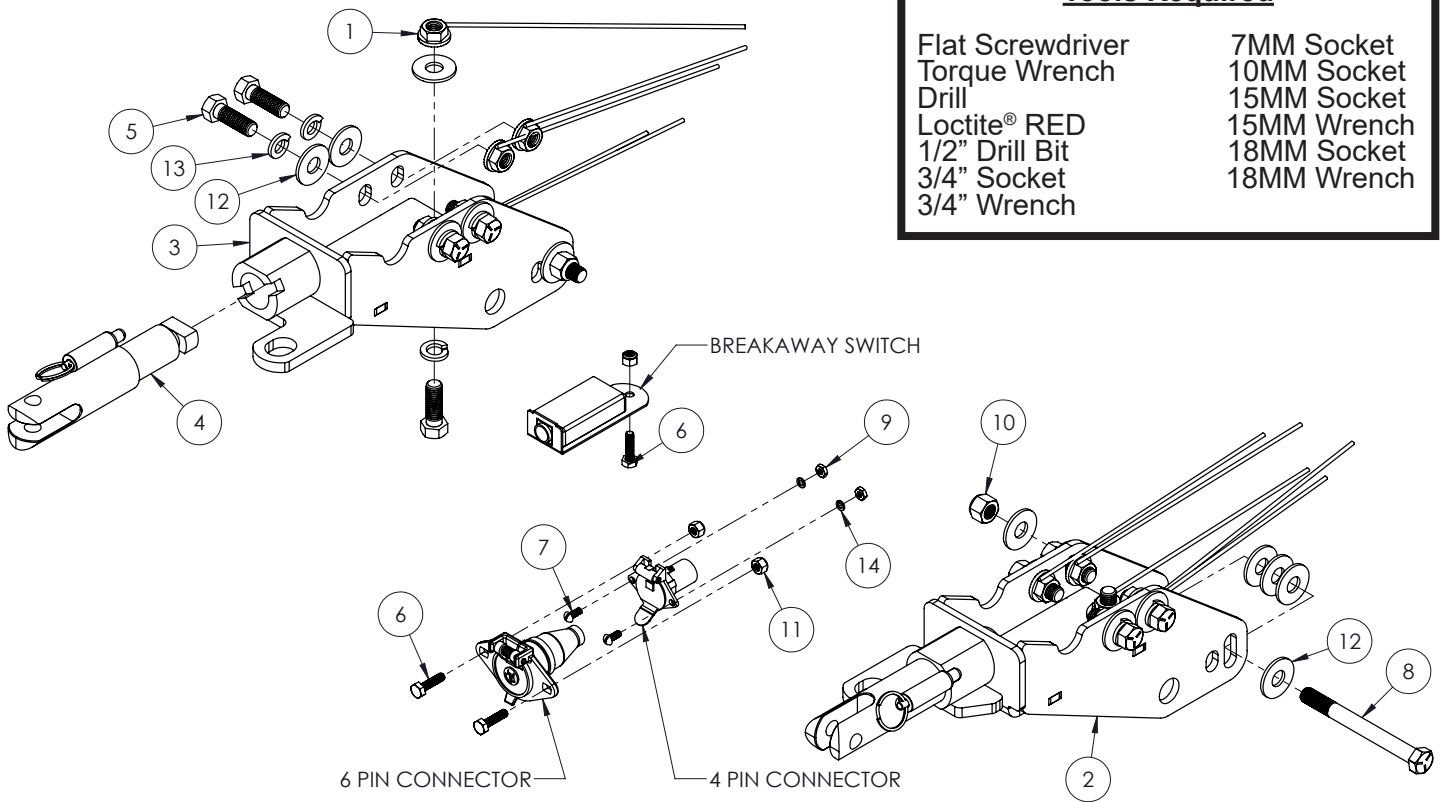

Item No.	Part No.	Description	Qty.
1.....	61-4029.....	1/2"-13 Whiz Nut w/ 10" Wire .....	10
2.....	61-8565.....	BX1754 Baseplate, DS.....	1
3.....	61-8566.....	BX1754 Baseplate, PS.....	1
4.....	62-3468.....	Attachment Tab Assembly with Hole .....	2
5.....	201-0051.....	1/2"-13 x 1-1/2" Hex Head Bolt, Grade 5, ZP .....	10
6.....	201-0071.....	1/4"-20 x 1" Hex Head Bolt, Grade 5, ZP .....	3
7.....	201-0192.....	#10-32 1/2" Round Slotted Head Screw.....	2
8.....	201-0786.....	1/2"-13 x 5" Hex Head Bolt, Grade , ZP .....	2
9.....	202-0047.....	#10-32 Hex Nut .....	2
10.....	202-0094.....	1/2"-13 Hex Nylon Insert Lock Nut, ZP.....	2
11.....	202-0102.....	1/4"-20 Hex Nylon Nut, ZP .....	3
12.....	203-0005.....	1/2" Flat Washer .....	20
13.....	203-0012.....	1/2" Lock Washer, ZP .....	10
14.....	203-0054.....	#10 Lock Washer, ZP .....	2
15.....	226-0049(not shown).....	Class IV Safety Cables.....	2
16.....	229-0512(not shown).....	1/2" Quicklink, ZP .....	2
17.....	290-0437(not shown).....	Black Cap Plug Receiver.....	2

**Important:**

Use only genuine factory replacement parts on your baseplate. Do **NOT** substitute homemade or non-typical parts. If a bolt is lost or in need of replacement, for your safety and the preservation of your baseplate, be sure to use a replacement bolt of the same grade (In most cases it will be Grade 5, please reference the parts list above). Replacement parts may be ordered through your nearest Blue Ox® Dealer or Distributor. Failing to follow and/or altering these installation instructions in either installation or required equipment will void the manufacturer's warranty. Towing behind a non-motorized vehicle will void the warranty.

BX1754  
2022-2024 Chevy Silverado 1500 (No Limited or ZR2)  
Installation Instructions

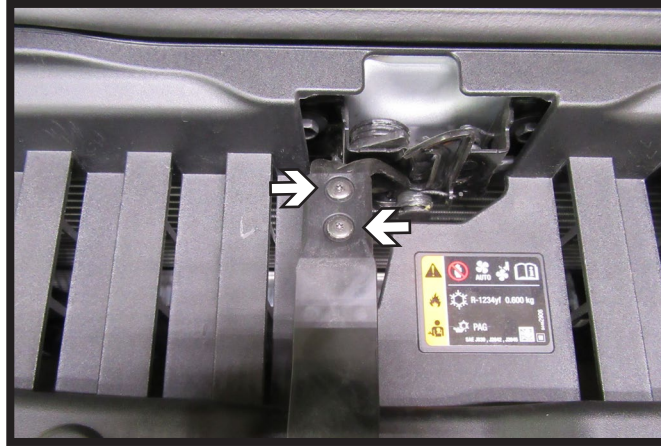

1. Using a T15 Torx, remove the two (2) bolts from the handle on the top edge of the fascia. Remove and set aside to be reinstalled later.

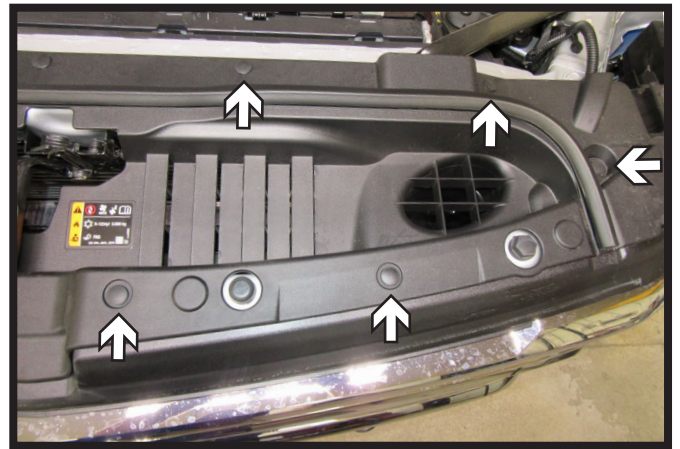
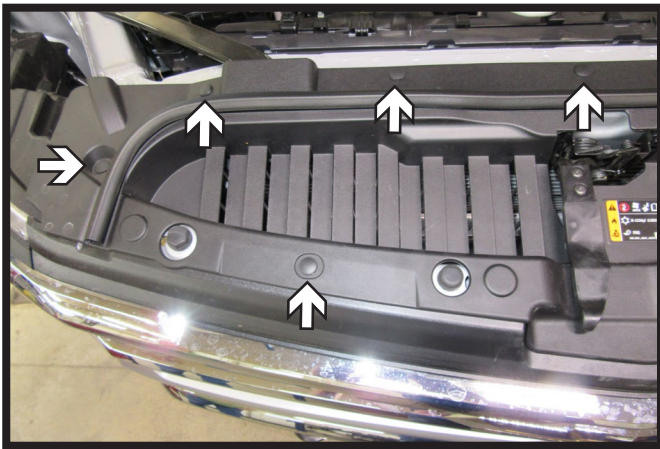

2. Remove the ten (10) push pins from along the top of the fascia. Remove fascia cover and set aside to be reinstalled later.

BX1754  
2022-2024 Chevy Silverado 1500 (No Limited or ZR2)  
Installation Instructions

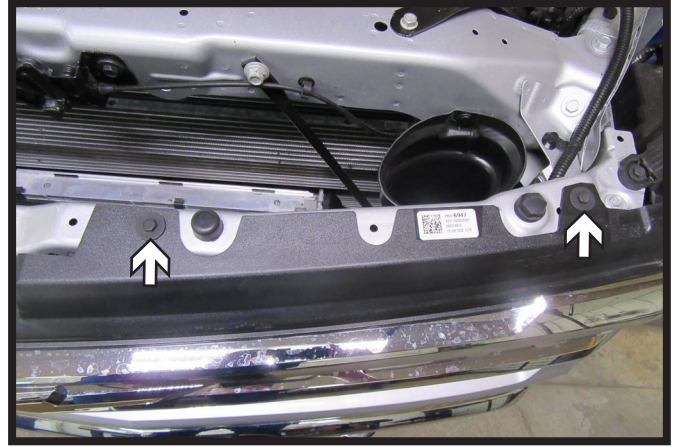
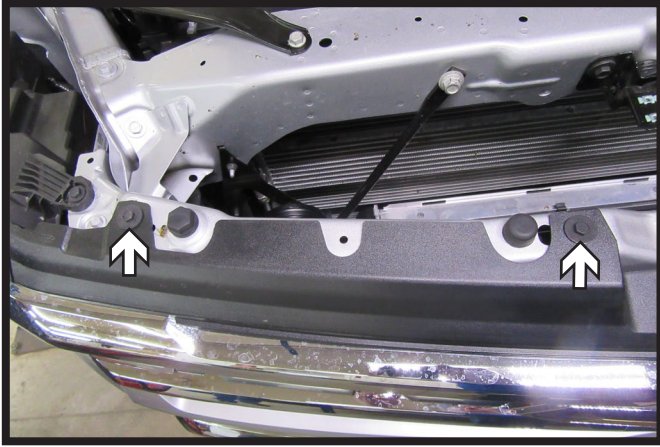

3. Using a 7MM socket, remove the four (4) bolts, two (2) on each side from the top of the fascia.



4. Using a T15 Torx, remove the four (4) bolts along the wheel well edge. Do this on both sides of the vehicle.



5. Pull back the wheel well liner. Using a 7MM socket, remove the three (3) bolts from the fascia joint. Do this on both sides of the vehicle.

BX1754  
2022-2024 Chevy Silverado 1500 (No Limited or ZR2)  
Installation Instructions



6. Starting on one side of the vehicle, lift and pull the center fascia piece away from the vehicle. Then unsnap piece across the front of the vehicle and finally lifting and pulling piece away from other side. Set center fascia piece aside to be reinstalled later.

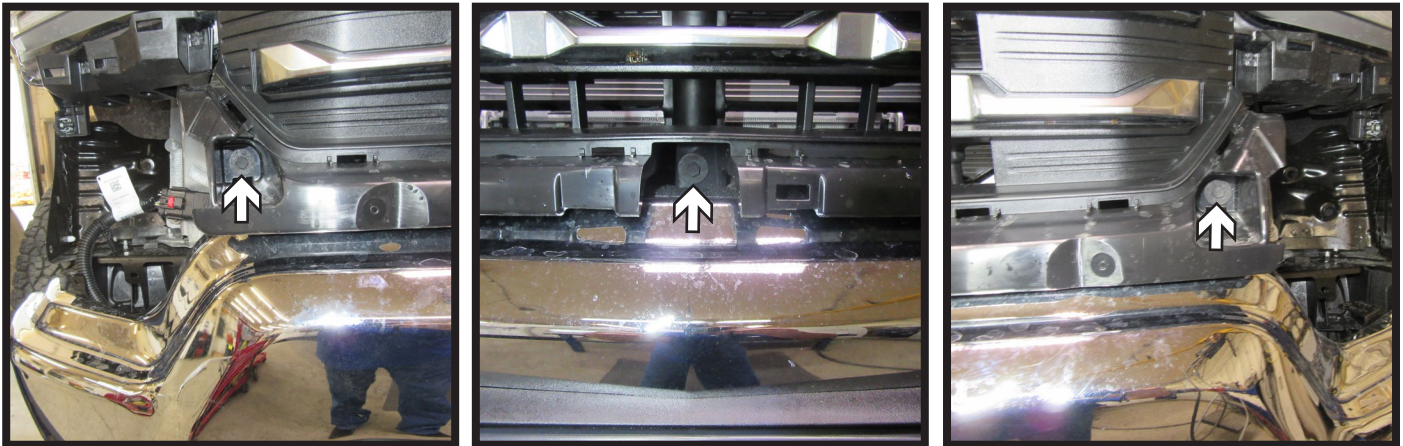

7. Using a 10MM socket, remove the three (3) bolts from the bottom edge of the grille piece. There is one (1) bolt on each side and one (1) in the center.

BX1754  
2022-2024 Chevy Silverado 1500 (No Limited or ZR2)  
Installation Instructions

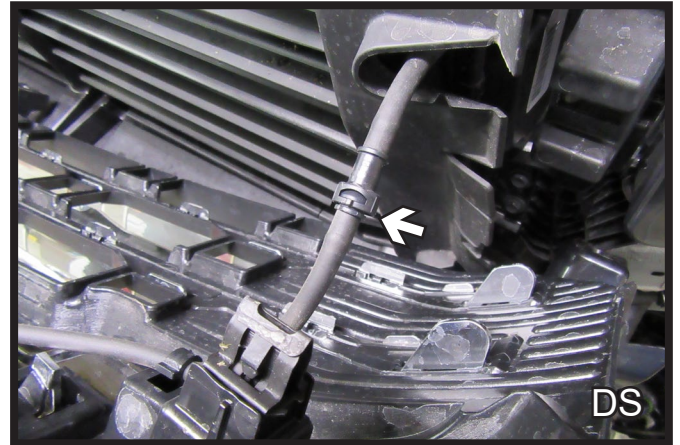
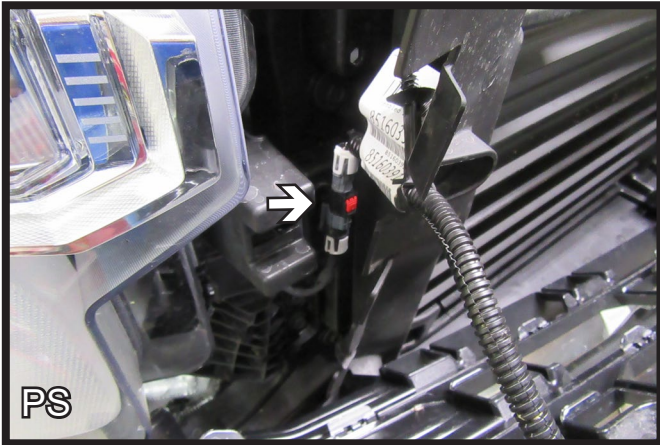

8. As the grille piece is removed, unplug the wire loom on the passenger side of the vehicle and disconnect the washer line for the camera on the driver side of the vehicle. Remove grille from the vehicle and set aside to be reinstalled later.

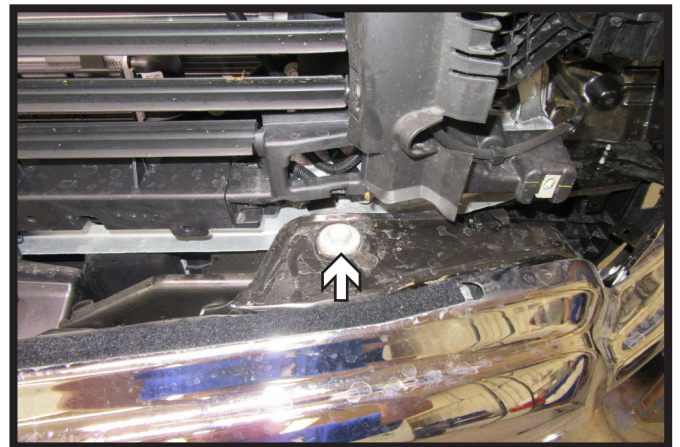
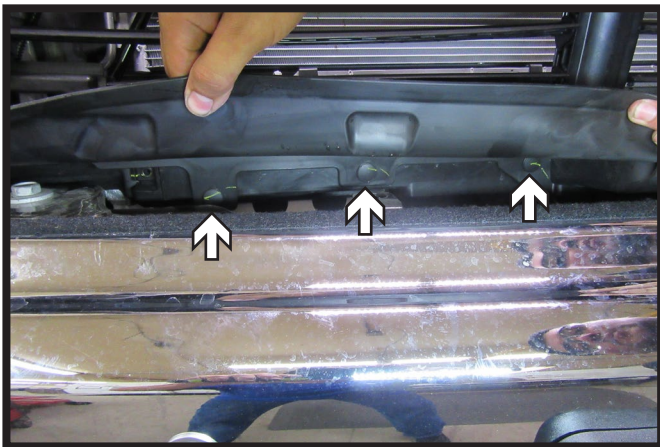

9. Pull up on the shroud above the bumper. Remove the seven (7) push pins from the underside of the shroud. There are three (3) on the driver side and four (4) on the passenger side. Remove shroud piece and set aside to be reinstalled later.
10. Using an 18MM socket, remove the two (2) bolts from the top edge of the bumper. There is one (1) on each side.

BX1754  
2022-2024 Chevy Silverado 1500 (No Limited or ZR2)  
Installation Instructions

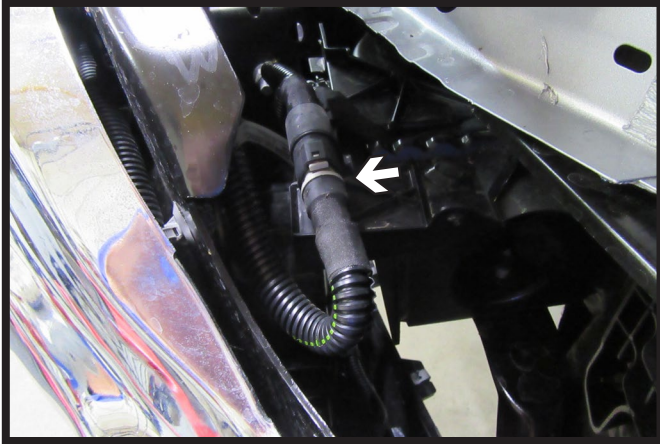

11. Unplug the electrical on the driver side of the vehicle.

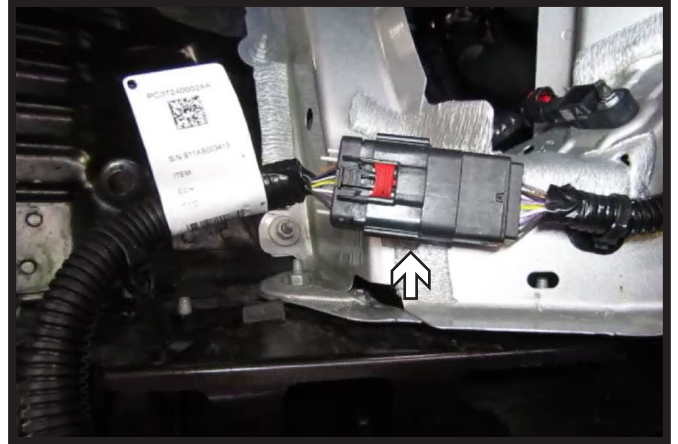

12. Unplug the electrical on the passenger side of the vehicle.

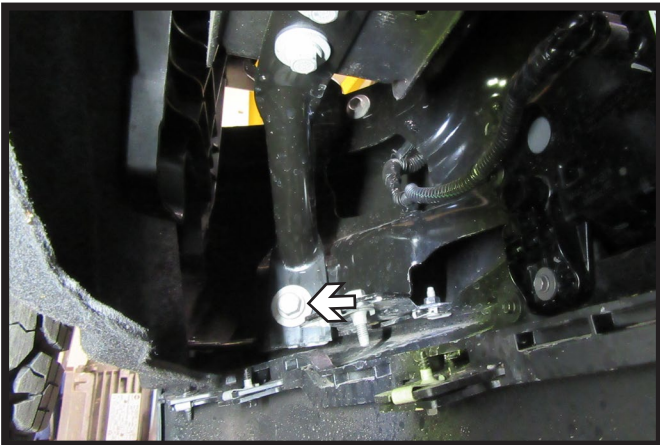

13. On the underside of the vehicle, use a 15MM socket to remove the one (1) bolt holding the bracket. Do this on both sides of the vehicle.

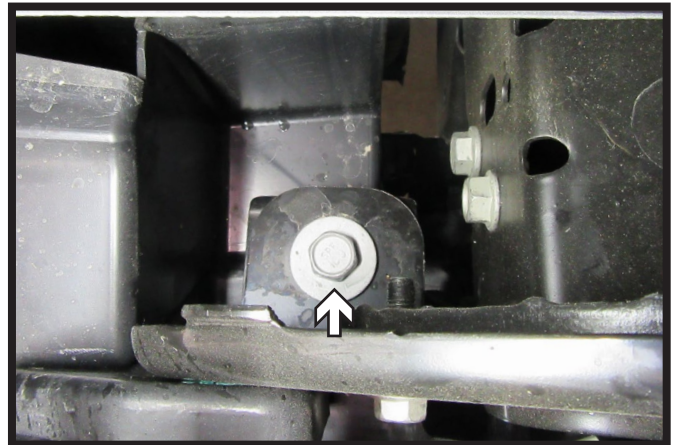

14. Using an 18MM socket, remove the one (1) bolt behind bumper from the top. Do this on both sides of the vehicle. Remove bumper and set aside to be reinstalled later.



BX1754  
2022-2024 Chevy Silverado 1500 (No Limited or ZR2)  
Installation Instructions

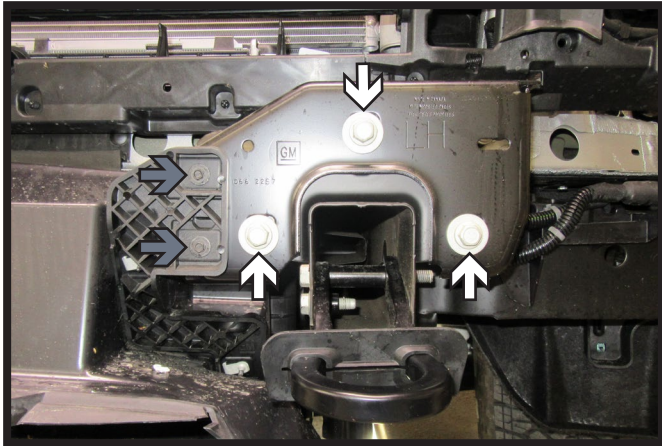

15. Using a 15MM socket, remove the three (3) bolts (white) from the front of the tow hook housing. Then using a 7MM socket, remove the two (2) bolts (gray). Remove front piece and set aside to be reinstalled later. Do this on both sides of the vehicle.

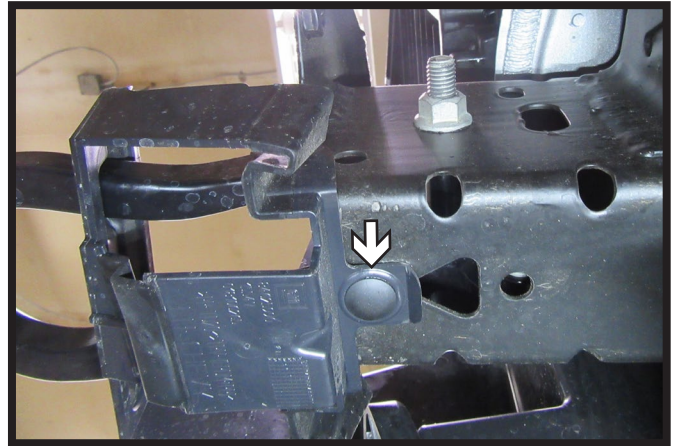

16. Remove the one (1) push pin from the bottom of the tow hook cover. Remove cover from the tow hook, it will not be reinstalled. Do this on both sides of the vehicle.

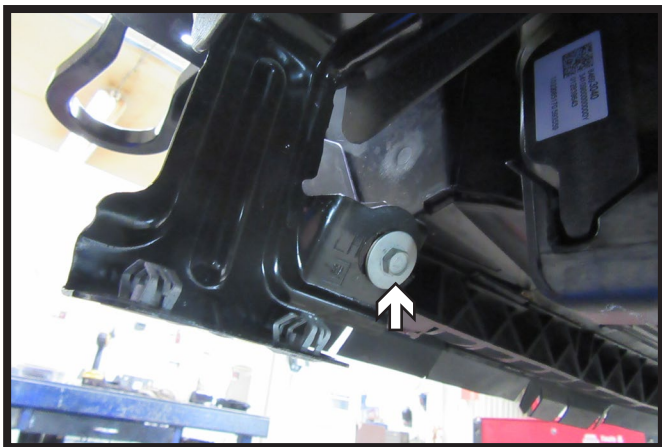

17. Using a 10MM socket, remove the one (1) bolt from the back of the lower shutters on the driver side of the vehicle.

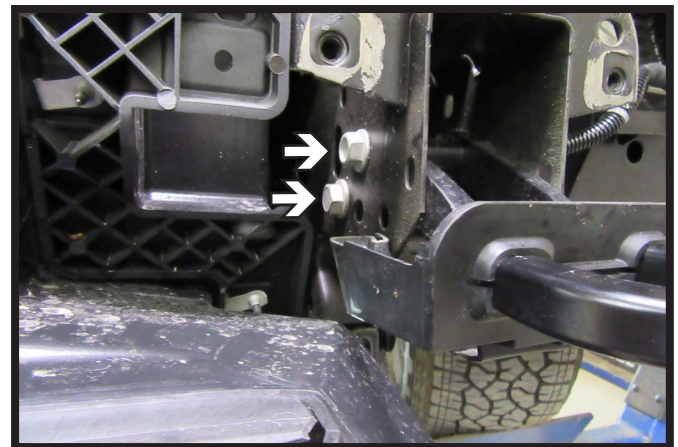

18. Using an 18MM socket, remove the two (2) bolts from the tow hook. Remove tow hook, it will not be reinstalled. Do this on both sides of the vehicle.

BX1754  
2022-2024 Chevy Silverado 1500 (No Limited or ZR2)  
Installation Instructions

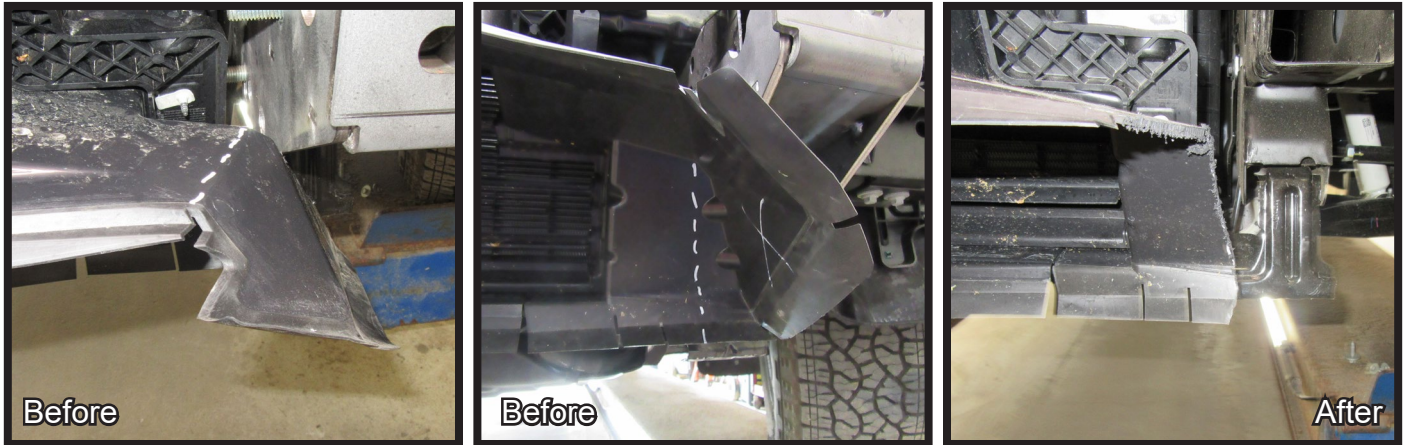

19. Using a reciprocating saw, trim the shutter housing as shown. Do this on both sides of the vehicle.

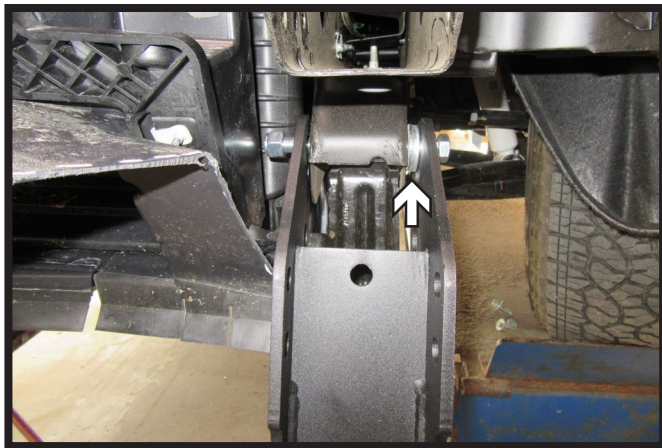

20. Slide baseplate onto tow hook housing so that the back slotted hole of the baseplate lines up with back hole on housing. Insert the one (1) 1/2" x 5" bolt with washers on the outside and three (3) spacer washers as shown. Leave loose at this time. Do this on both sides of the vehicle.

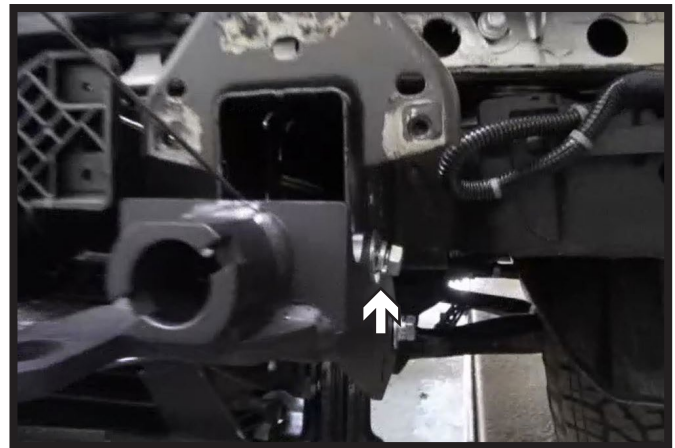

21. Rotate baseplate upward and start 1/2" bolt with hardware in the outer front hole. Do this on both sides of the vehicle.  
**Note:** If top front holes do not line up, the back lower bolt may need to be switched to the other slotted hole.

BX1754  
2022-2024 Chevy Silverado 1500 (No Limited or ZR2)  
Installation Instructions

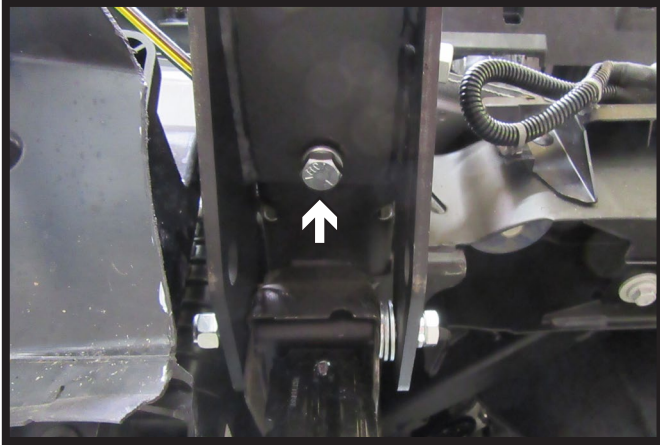

22. Install a 1/2" bolt with lock washer on bottom and a flat washer with whiz nut on top into bottom hole of the baseplate. Do this on both sides of the vehicle. Remove side bolts, apply Loctite Red and reinstall. Do this on both sides of the vehicle.

**\*\* Use Loctite® Red on all bolt threads and tighten all bolts to the appropriate torque. \*\***

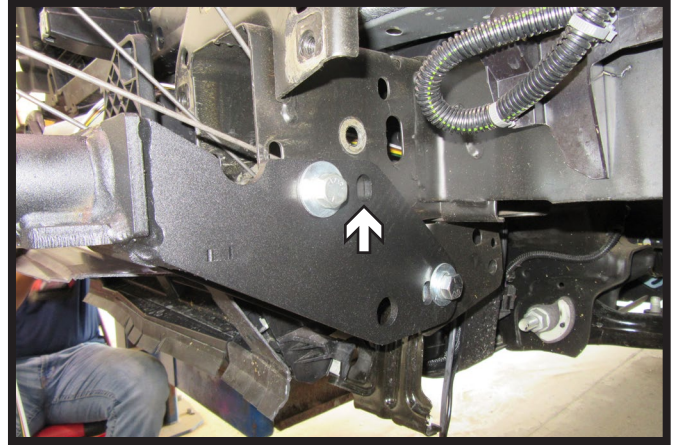

23. Using a 1/2" drill bit, drill the top rear outside hole on the driver side of the vehicle, using the baseplate as a template.



24. Using a 1/2" drill bit, drill the top rear inside hole on the passenger side of the vehicle, using the baseplate as a template. Drill straight through the tow hook housing from the rear outside hole to drill rear inside hole.

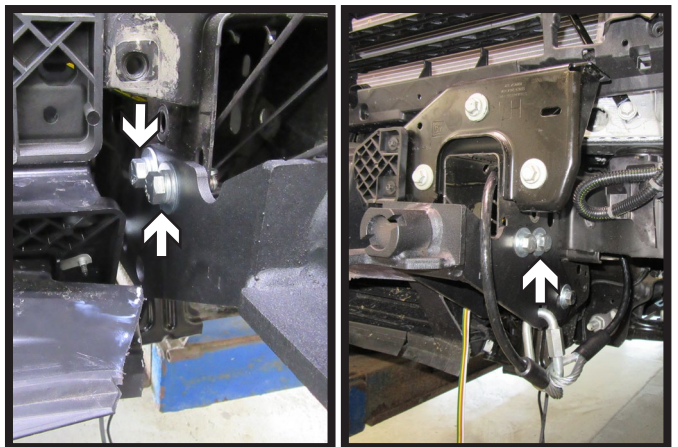

25. Install the three (3) remaining 1/2" bolts with lock washers, flat washers, and whiz nuts into the two (2) inside holes and one (1) outside rear hole on the baseplate. Do this on both sides of the vehicle.

**\*\* Use Loctite® Red on all bolt threads and tighten all bolts to the appropriate torque. \*\***

BX1754  
2022-2024 Chevy Silverado 1500 (No Limited or ZR2)  
Installation Instructions



26. Attach the permanent baseplate safety cables to the provided convenience link on the baseplate. The photo above shows the recommended installation of the cables to frame of vehicle. Additional options may interfere with suggested mounting; in this case, secure the cables to a solid piece of the frame as described in the General Information sheet. Be sure the safety cables do not rub against any hoses or moving parts. Do this on **BOTH** sides of the vehicle.

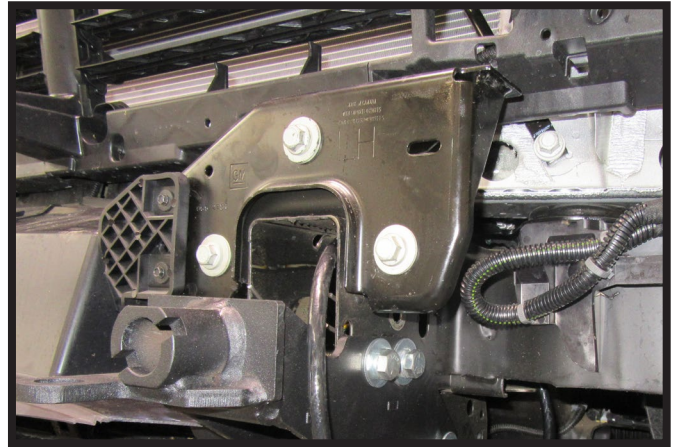

27. Reinstall the tow hook housing front plate. Then reinstall lower shutter bolt on driver side of the vehicle.

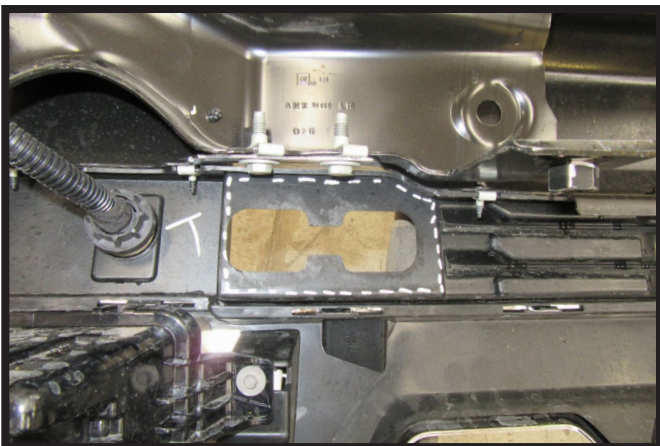

28. Using a reciprocating saw, trim the indicated area around tow hook opening on the back of the bumper to allow clearance for baseplate. Do this on both sides of the vehicle. Reinstall bumper and reconnect electrical.



29. Reinstall plastic shroud above bumper.

BX1754  
2022-2024 Chevy Silverado 1500 (No Limited or ZR2)  
Installation Instructions



30. Reinstall upper grille piece and reconnect remaining electrical connections.



31. Reinstall center fascia piece, fascia cover and handle.

## CUSTOMER SERVICE COMMITMENT

Blue Ox® is committed to providing you with exceptional customer care throughout your lifetime with our products. Our team is here to assist you with any questions you may have regarding the performance of your product. Simply call (402) 385-3051 and you can speak with our technical service team.

Additionally, please visit our website to see which rallies our Destination America team will be attending. For a nominal fee, our service technician will service your towing system to ensure it's in proper working condition. Also, as a commitment to our customers, should you visit our factory, you can stay at our full service Blue Ox® campground at no charge along with enjoying a factory tour.

Again, thank you for being our customer and for the confidence you have shown in the performance of our products. It is because of customers like you we enjoy the success we have today.

© 2022 Blue Ox  
One Mill Road, Industrial Park  
Pender, Nebraska 68047  
Phone: (402) 385-3051  
Fax: (402) 385-3360  
[www.blueox.com](http://www.blueox.com)

# General Information

1. Ensure that your product(s) are registered online at [www.blueox.com](http://www.blueox.com). It is crucial to register your product(s) so that you may be alerted of product offerings, updates, upgrades, maintenance and safety bulletins, and/or recalls.
2. **It is the owner's responsibility to inspect all towing equipment for cracked welds, missing or worn parts and loose bolts before each towing trip.** Be sure to use Loctite® Red on all bolts and tighten to the recommended specifications.
3. **It is the owner's responsibility to hook up all towing equipment per manufacturer's instructions/recommendations.**
4. Remove the attachment tabs when not in use (if applicable).

## Notice To Baseplate Installer

### 1. It is YOUR responsibility to watch for:

- Oil cooler and air conditioner lines
- Electrical wires and hoses
- Missing parts or attaching points on the frame

\*\* If the baseplate is improperly installed and is against a wire or hose, it could cause fluid leaks or electrical shorts some time after the actual baseplate installation.

## Permanent Baseplate Safety Cable Installation

Permanent baseplate safety cables are strongly recommended when towing a vehicle with a tow bar. The principle function of the permanent baseplate safety cables is to prevent the towed vehicle from breaking loose in the event the connection between the frame of the towed vehicle and the baseplate fails or becomes disconnected. The cables must be connected from the baseplate to the frame rail or cross member of the vehicle's frame. The illustrations below show the possible arrangements recommended by Blue Ox®. Each permanent baseplate safety cable must have an adequate weight rating for the towing system. The weight rating of the two (2) cables together will not qualify.

***Do not mount the permanent baseplate safety cables against wires, hoses or brake lines.***

These permanent baseplate safety cables should remain installed as long as the baseplate is installed on the vehicle. Permanent baseplate safety cables are to be used in conjunction with, and NOT a replacement for legally required safety cables attaching the towed vehicle to the towing vehicle.

### Option #1

(Baseplates with Convenience Link Tabs)

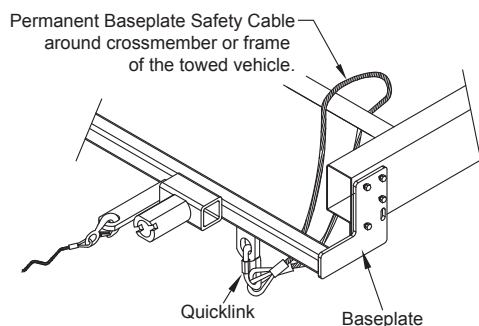

### Option #2

(Baseplates with out Convenience Link Tabs)

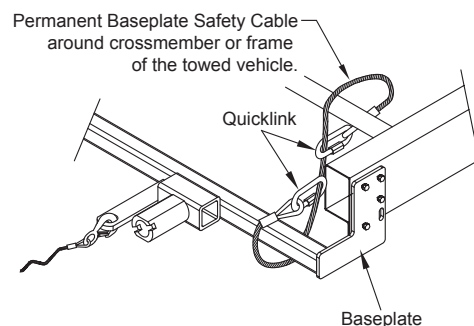

# BLUE OX ORIGINAL PURCHASERS THREE YEAR LIMITED WARRANTY

Automatic Equipment Manufacturing Company ("Automatic") warrants to the original (first) retail purchaser that this product, manufactured by Automatic, shall be free from defect in material and workmanship under normal use and service for a period of three years from the date of delivery.

During said three-year period, Automatic will repair or replace any parts that have been returned by the original purchaser, to the factory, transportation prepaid, and in Automatic's sole and absolute opinion found to be defective.

Limitations on Warranty Coverage:

Coverage under this warranty will be valid only if the customer warranty card is returned by the original purchaser within 30 days of purchase.

Coverage under this warranty will be effective only when a copy of the original invoice, showing date and place of purchase, accompanies any claim for warranty. This warranty is NON TRANSFERABLE.

This limited warranty will not cover, in any way or form, any alleged damages caused by incorrect or improper installation, improper use, modification or neglect of product, failure to properly service and maintain, misuse, act of God, accident or failure of the user to follow guidelines contained in the instructional material provided by Automatic.

This warranty does not cover normal wear and tear, paint or rust.

Warrantor assumes no responsibility to the owner for loss of use of product, loss of time, inconvenience or any other damage consequential or otherwise. Including, but not limited to mileage, expense of transporting of product, return shipping expense, mechanics travel time, telephone, road service, towing, and rental during repairs, travel, lodging, loss or damage to personal property or loss of earnings.

**REPAIR OR REPLACEMENT AS SET FORTH IN THIS LIMITED WARRANTY IS THE SOLE EXCLUSIVE REMEDY OF THE PURCHASER. AUTOMATIC SHALL NOT BE LIABLE FOR ANY INCIDENTAL OR CONSEQUENTIAL DAMAGES FOR BREACH OF ANY EXPRESS OR IMPLIED WARRANTY ON THIS PRODUCT. EXCEPT TO THE EXTENT PROHIBITED BY APPLICABLE LAW, ANY IMPLIED WARRANTY OF MERCHANTABILITY OR FITNESS FOR A PARTICULAR PURPOSE ON THIS PRODUCT IS LIMITED IN LENGTH TO THE DURATION OF THIS WARRANTY.**

Please visit <http://blueox.com/warranty/> to register your warranty



**BLUE OX**