



**BLUE OX®**

Baseplate Installation Instructions

BX2326

2007-08 Hyundai Entourage

2006-10 Kia Sedona SX/LX

Installation Instructions

Serial Number

Please read BOTH these Installation Instructions and the General Towing Instructions before attempting to install or operate this equipment.

1. Blue Ox® towing products and accessories are intended to be installed by Blue Ox® Dealers who are familiar with our products and have the equipment and knowledge to do “fit work.” When necessary, Blue Ox® Dealers can be found at [www.blueox.com](http://www.blueox.com) or by contacting our Customer Care Department at (402) 385-3051.

Attachment Tab Height: 14 1/2”  
Attachment Tab Width: 21”

2. Many Blue Ox® Baseplates are designed to use existing holes and hardware to mount the baseplate to the towed vehicle. Even though bolts are there, do not assume they are adequate for baseplate mounting. Always use hardware supplied in the hardware kit or existing hardware specified in the Baseplate Towing Installation Instructions.

**Bolt Torque Specifications**

Torque in Foot-Pounds for Metric Bolts

Bolt Size	Grade 8.8	Grade 10.9
6MM	6	8
8MM	16	22
10MM	31	40
12MM	54	70
14MM	89	117

Confirm the towability and pre-towing procedures for your vehicle with the owner’s manual or contact the vehicle’s manufacturer for specific towing procedures.

**Bolt Torque Specifications**

Torque in Foot-Pounds for Inch Bolts

Bolt Size	Grade 5	Grade 8
1/4”	10	14
5/16”	19	29
3/8”	33	47
7/16”	54	78
1/2”	78	119
5/8”	154	230

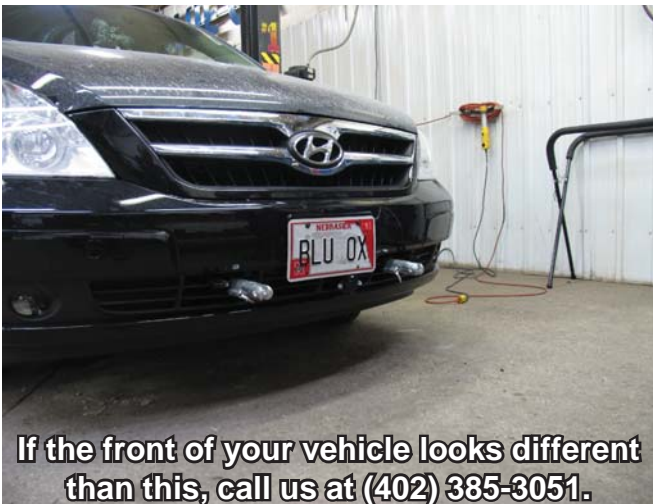

If the front of your vehicle looks different than this, call us at (402) 385-3051.

**! WARNING**

Failure to read and follow these instructions could result in separation of the towed vehicle from the tow bar, causing property damage, loss of towed vehicle, personal injury or death.

BX2326  
2007-08 Hyundai Entourage  
2006-10 Kia Sedona SX/LX

Installation Instructions

**Parts List**

Ref. No.	Qty.	Part #	Description
1	1	61-6365	Weldment, Baseplate, BX2326
2	7	61-5208	Weldment, Nut Plate, 1/4x1x1, 3/8 Bolt w/10" Wire
3	2	201-0446	8MM-1.25x30MM Hex Bolt, Grd 8.8, ZP
4	7	201-0368	3/8-16x1 1/4" Hex Bolt, Grd. 5, ZP
5	9	203-0010	3/8 Lock Washer, ZP
6	2	203-0003	3/8 Flat Washer, ZP
7	2	201-0553	1/4-20x1/2" Hex WSHD, Type F Screw
8	2	201-0192	#10-32x1/2" Slot, Round Head Screw
9	2	203-0054	#10 Lock Washer
10	2	202-0047	#10-32 Hex Nut
11	2	101-5822	Adapter, 4 Way Connector
12	2	62-3468	Attachment, Assembly, SF/SB, 1 Hole
	2	290-0437	Cap Plug, Black (Not Shown)
	2	229-0359	Quicklink, 3/8", ZP (Not Shown)
	2	226-0046	Baseplate Safety Cable, 36" Class III (Not Shown)

**Tools Required**

- Loctite® RED
- 7MM Socket
- 8MM Socket
- 10MM Socket
- 12MM Socket
- 13/32 Drill Bit
- Vise Grips
- Hack Saw Blade
- Reciprocating Saw
- Phillips Screwdriver

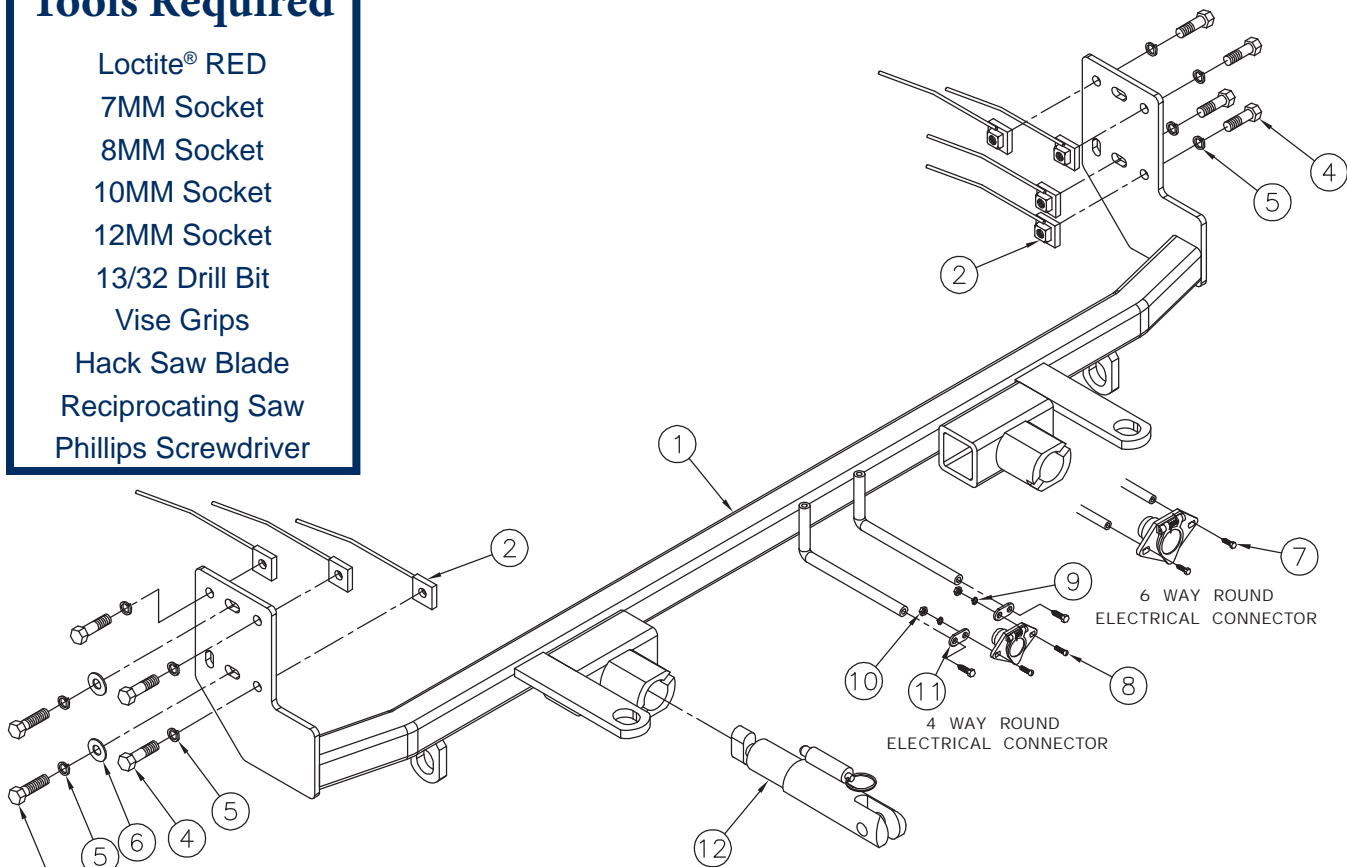

**Important:**

Use only genuine factory replacement parts on your baseplate. Do **NOT** substitute homemade or non-typical parts. If a bolt is lost or in need of replacement, for your safety and the preservation of your baseplate, be sure to use a replacement bolt of the same grade (In most cases it will be Grade 5, please reference the parts list above). Replacement parts may be ordered through your nearest Blue Ox® Dealer or Distributor. Failing to follow and/or altering these installation instructions in either installation or required equipment will void the manufacturer's warranty.

BX2326  
2007-08 Hyundai Entourage  
2006-10 Kia Sedona SX/LX  
Installation Instructions

**Vehicle Weight:**

Motorhome mount tow bars are recommended for use with this baseplate. Due to the design of the removable tabs, the RangefinderII and Ambassador tow bars can not be used. Adapters, except the BX8833 and BX88151, can not be used with this baseplate.

**Installation Notes:** The fascia, metal bumper and headlights are removed and reinstalled during installation of the baseplate. Drilling is required. Trimming of the fascia is required.

The dimensional variations between otherwise identical vehicles can be considerable. While the baseplate was designed for easy installation, it may be necessary to tailor the baseplate slightly to compensate for auto manufacturer's tolerances. These minor adjustments may include filing a hole slightly, bending electrical rods or bending end plates.

The BX8869 Bulb and Socket Wiring Kit is recommended for this vehicle.

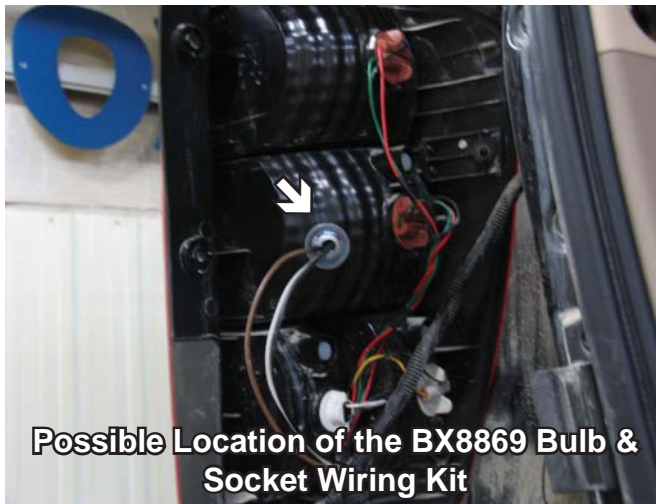

**Installation Instructions:**



1. Using a Phillips screwdriver, remove thirteen plastic Phillips push pins all together from the top plastic piece. There are six push pins located on the driver side and passenger side and one push pin in the middle. Set push pins aside to be reinstalled later.



2. Using a 10MM socket, remove one metric bolt located by headlight. Do this to both sides of the vehicle. Set bolts aside to be reinstalled later.

Handling of some cosmetic parts when installing this product may require the use of protective covers, rags, specialty tools, etc. to prevent damage.

BX2326  
2007-08 Hyundai Entourage  
2006-10 Kia Sedona SX/LX  
Installation Instructions



3. Use a 8MM socket for the Hyundai, a 10MM for the Kia, remove one metric bolt just forward of the front tire, on the wheel well. Do this to both sides of the vehicle. Set bolts aside to be reinstalled later.



4. Using a Phillips screwdriver, remove thirteen plastic Phillips push pins located just forward of the front tire along the bottom edge of fascia, from the driver side to the passenger side of the vehicle. Set push pins aside to be reinstalled later.



5. On the Hyundai, using a 10MM socket, remove bolt from headlight assembly and then pull headlight forward to remove. Do this to both sides of the vehicle. Set headlight assemblies and bolts aside to be reinstalled later.



6. Once headlight assembly is removed, you will need to remove one metric bolt with a 10MM socket and two plastic Phillips push pins with a Phillips screwdriver. Do this to both sides of the vehicle. Set bolts and push pins aside to be reinstalled later. The fascia is then ready to be removed from the vehicle and set aside carefully to be reinstalled later.

BX2326  
2007-08 Hyundai Entourage  
2006-10 Kia Sedona SX/LX  
Installation Instructions

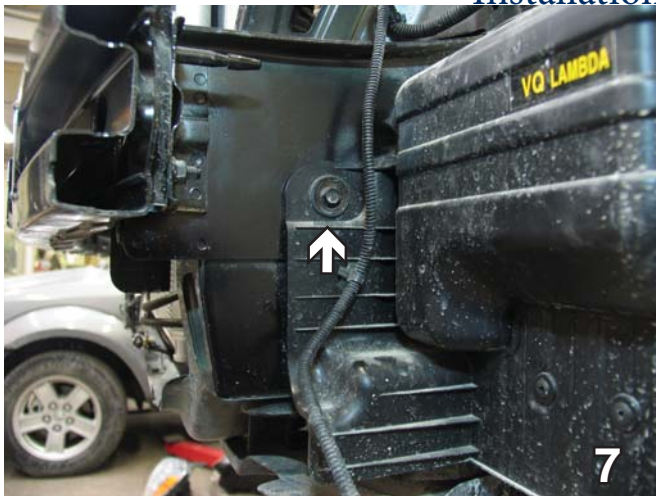

7. Using a 10MM socket, remove one metric bolt located near the air dam on the driver side of the vehicle. Set bolt aside to be reinstalled later.



8. You will need to grind off a small tab, indicated in the photo above on the driver side only.

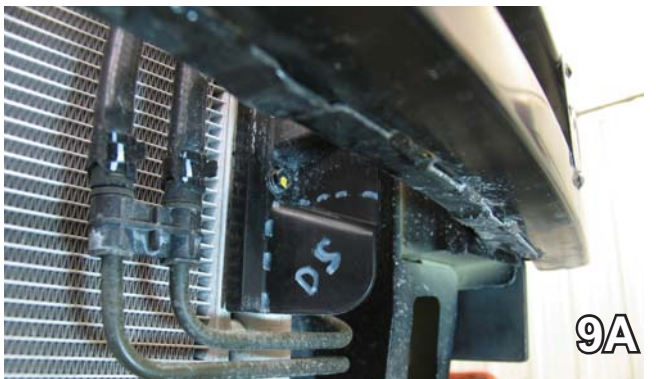

9. You will need to trim the plastic piece located under the metal bumper so it's flush with the bottom of the bumper. Do this to both sides of the vehicle.



10. Using a 12MM socket, remove two bolts located on top of the metal bumper and a nut located on the back side of the metal bumper. Do this to both sides of the vehicle. Set metal bumper, bolts and nuts aside to be reinstalled later.

BX2326  
2007-08 Hyundai Entourage  
2006-10 Kia Sedona SX/LX  
Installation Instructions

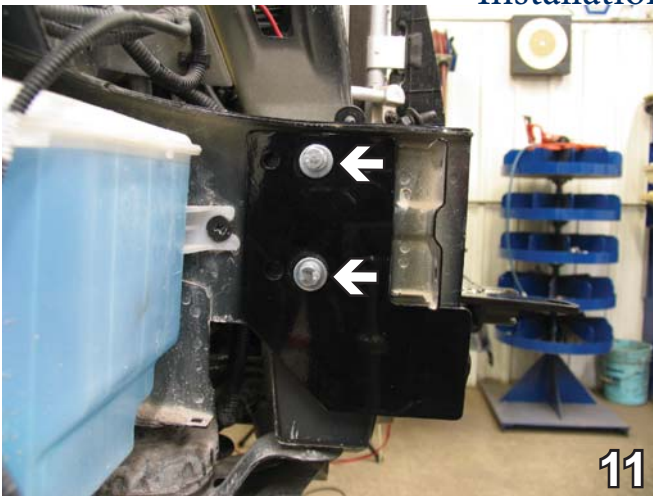

11. Slide baseplate up so that the holes on the baseplate line up with the existing holes in the frame on the passenger side. Clamp baseplate in place with vise grips. Insert a 8MM-1.25x30MM hex bolt, 3/8" lock washer and 3/8" flat washer into the two existing holes and tighten down.

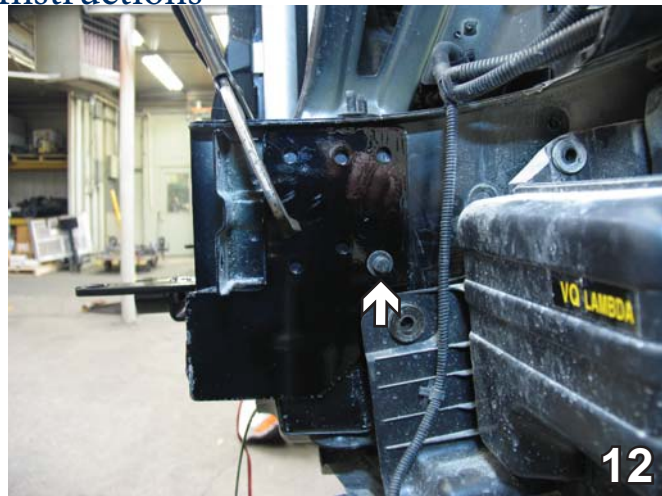

12. On driver side, insert bolt removed in Step 7 and tighten down. This is just to hold baseplate in place so the other holes in the baseplate can be drilled. The bolt will be removed again so the air dam can be put back into place.

**BE SURE TO USE LOCTITE® RED ON ALL BOLTS BEFORE TIGHTENING. TIGHTEN ALL BOLTS ACCORDING TO THE TORQUE CHART ON THE FRONT PAGE OF THESE INSTRUCTIONS OR ON PAGE 3 OF THE BASEPLATE TOWING GENERAL INSTRUCTIONS.**

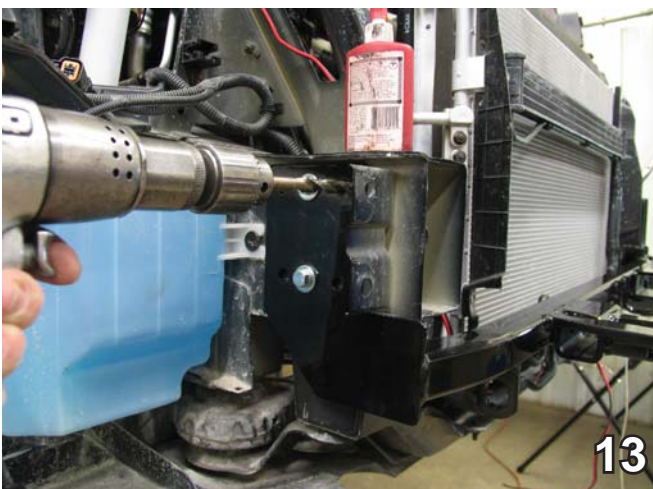

13. Using the baseplate as a template, drill the remaining holes into the frame with a 13/32" drill bit. Insert the nut plates into the frame and align with drilled holes. Insert a 3/8-16x1 1/4" hex bolt and 3/8" lock washer into the holes and tighten down with nut plates.

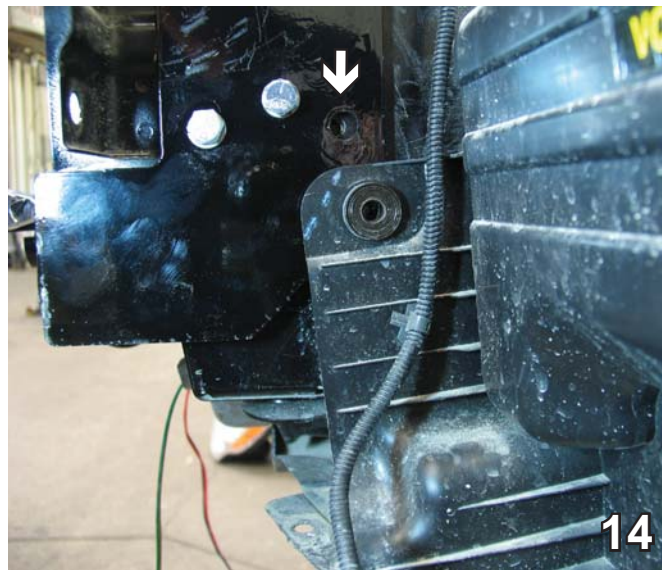

14. Remove existing bolt from baseplate and bolt the air dam back into place. Before you reinsert the bolt, place a flat washer on and then tighten down.

**When using power drills be aware of the dangers of torque and drill bit length.**

BX2326  
2007-08 Hyundai Entourage  
2006-10 Kia Sedona SX/LX  
Installation Instructions

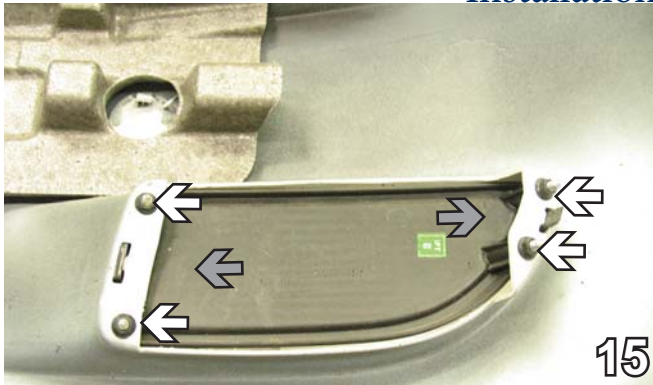

15. Remove the covering (grey arrows) from inside the bumper. Using a 7MM socket, remove four bolts. Do this on both sides. The bolts will be reinstalled after trimming.

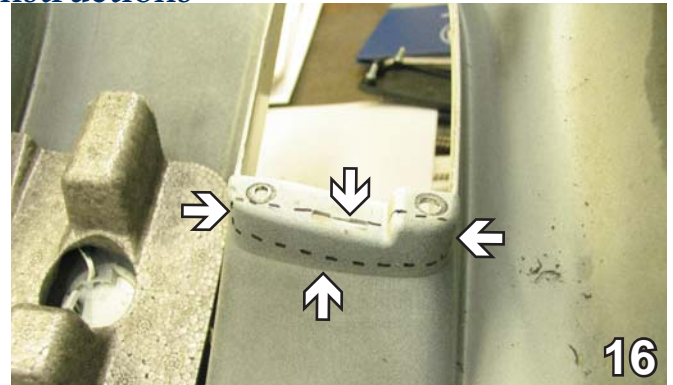

16. Using a reciprocating saw, trim next to the bolt holes and down about 5/8". Reinstall headlights, fascia, bumper, bolts and push pins.



17. Attach permanent baseplate safety cables to the convenience link on the baseplate. The photo above shows recommended installation of the cables to frame of vehicle. If vehicle has additional options (not shown above) which interfere with mounting permanent baseplate safety cables, secure the cables to a solid piece of the vehicle frame as described in instructions included with the permanent baseplate safety cables.



18. Align the fascia to its original position and using a hack saw blade, remove area around attachment tab receiver to allow for it to come through the fascia. Do this to both sides of the vehicle.

Install the tow bar and safety cables according to the instructions provided in their packages. When demonstrating this to the customer, be sure to include all the contents and packages.

Do **NOT** substitute other devices if the tow bar pins and clips are misplaced.

Be sure that **ALL** electrical connections are plugged in properly and functioning **BEFORE** installing the fascia.

BX2326  
2007-08 Hyundai Entourage  
2006-10 Kia Sedona SX/LX  
Installation Instructions

**DEALER or INSTALLER:**  
Be certain the user receives the  
instruction sheets for their products.

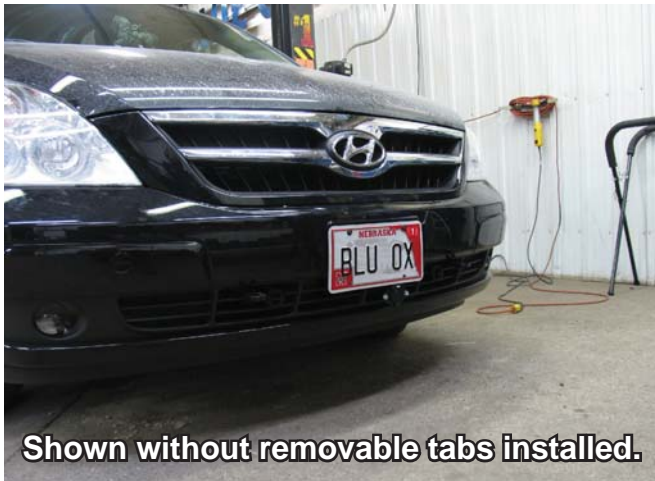

**Shown without removable tabs installed.**



**Shown with removable tabs installed.**

### CUSTOMER SERVICE COMMITMENT

Blue Ox is committed to providing you with exceptional customer care throughout your lifetime with our products. Our team is here to assist you with any questions you may have regarding the performance of your product. Simply call 1-402-385-3051 and you can speak with our customer care team.

Additionally, please visit our website to see which rallies our Destination America team will be attending. For a nominal fee, our service technician will service your towing system to ensure it's in proper working condition. Also as a commitment to our customers, should you visit our factory you can stay at our full service Blue Ox campground at no charge along with enjoying a factory tour.

Again thank you for being our customer and for the confidence you have shown in the performance of our products. It is because of customers like you we enjoy the success we have today.



© 2007, 11 Blue Ox  
One Mill Road, Industrial Park  
Pender, Nebraska 68047  
Phone: (402) 385-3051 • Fax: (402) 385-3360  
[www.blueox.com](http://www.blueox.com)