



Baseplate Installation Instructions

BX2711 2005 Kia Spectra Installation Instructions

Serial Number

Please read BOTH these Installation Instructions and the General Instructions before attempting to install or operate this equipment.

- Blue Ox® towing products and accessories are intended to be installed by Blue Ox® Dealers who are familiar with our products and have the equipment necessary and knowledge to do "fit work". When necessary Blue Ox® Dealers can be found at www.blueox.us or by contacting our 24/7 Customer Care Department at (402) 385-3051.
- Many Blue Ox® Baseplates are designed to use existing holes and hardware to mount the baseplate to the towed vehicle. Even though bolts are there, do not assume they are adequate for baseplate mounting. Always use hardware supplied in the hardware kit and existing hardware specified in the Baseplate Installation Instructions.

Attachment Tab Height: 14.5"

Attachment Tab Width: 22"

Bolt Torque Specifications		
Torque in Foot-Pounds per Metric Bolts		
Bolt Size	Grade 8.8	Grade 10.9
6MM	6	8
8MM	16	22
10MM	31	40
12MM	54	70
14MM	89	117

Confirm the towability and pre-towing procedures for your vehicle with the owner's manual or contact the vehicle's manufacturer for specific towing procedures. You can also contact REMCO for additional information at 1(800)228-2481.

Bolt Torque Specifications		
Torque in Foot-Pounds per Inch Bolts		
Bolt Size	Grade 5	Grade 8
1/4"	10	14
5/16"	19	29
3/8"	33	47
7/16"	54	78
1/2"	78	119
5/8"	154	230



! WARNING

Failure to read and follow these instructions could result in separation of the towed vehicle from the tow bar, causing property damage, loss of towed vehicle, personal injury or death.

BX2711 2005 Kia Spectra Installation Instructions

Parts List

Ref. No.	Qty.	Part #	Description
1	1	61-6210	Weldment, Baseplate, BX2711
2	8	61-5208	Weldment, 3/8-16 Nut Plate, with 14" Wire
3	8	201-0440	3/8-16 x 1 1/2" Hex Bolt, Grd. 5, ZP
4	8	203-0010	3/8" Lock Washer, ZP
5	2	201-0553	1/4-20 x 1/2" Hx. Wshd, Type F Screw
6	2	201-0192	#10-32 x 1/2" Slot Rd. Hd. Screw
7	2	203-0054	#10 Lock Washer
8	2	202-0047	#10-32 Hex Nut
9	2	101-5822	Adapter, 4 Way Connector
10	2	62-3468	Attachment, Assembly, SF/SB (R)
	2	226-0046	Baseplate Safety Cable, 36" CL III (Not Shown)
	2	229-0359	Quicklink, 3/8, ZP (Not Shown)
	2	290-0437	Cap Plug (Not Shown)

Tools Required

10MM Socket
12MM Socket
9/16" Socket
13/32" Socket

Vise Grips
Reciprocating Saw
Loctite® RED

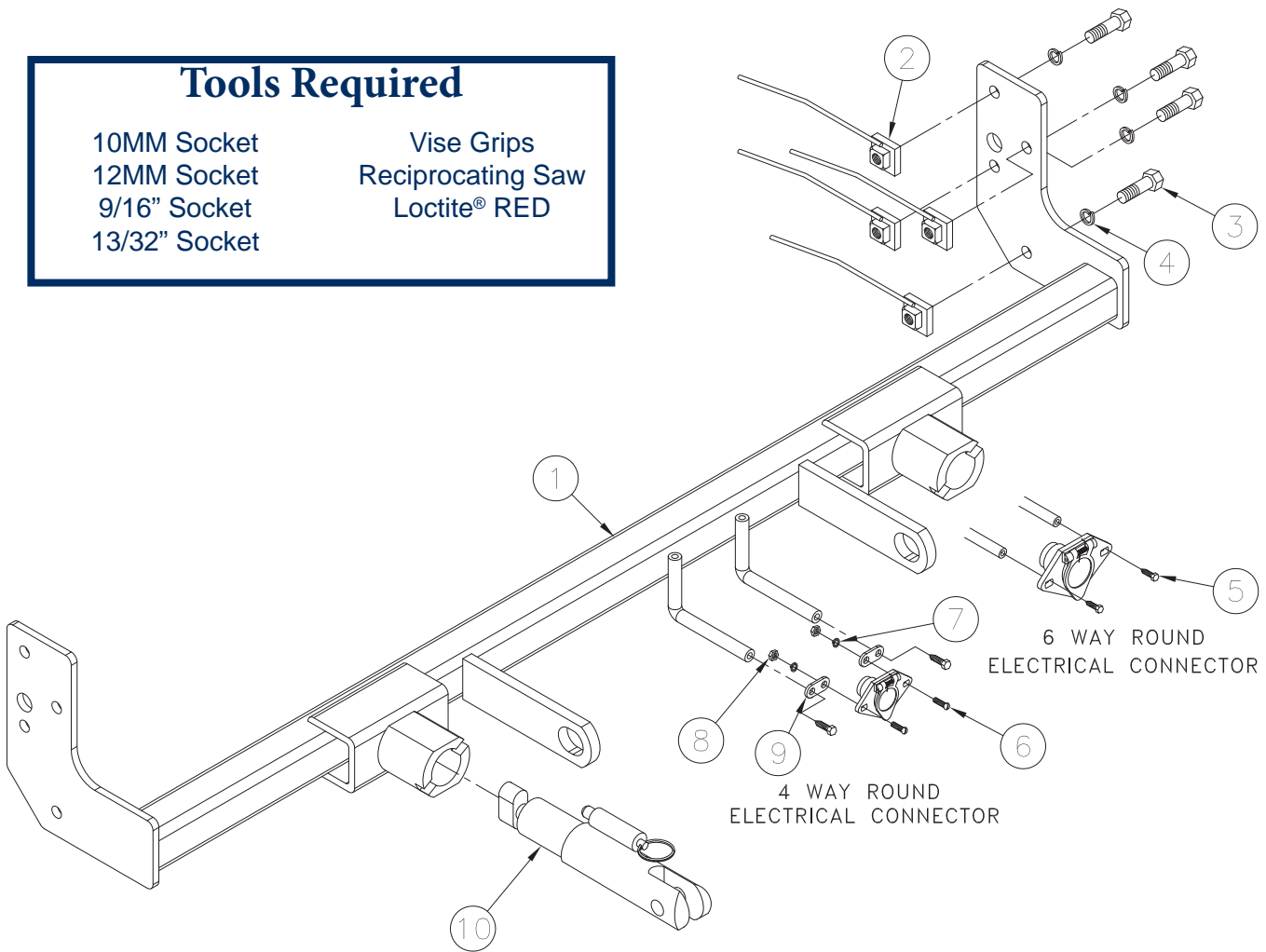

Important:

Use only genuine factory replacement parts on your baseplate. Do **NOT** substitute homemade or non-typical parts. If a bolt is lost or in need of replacement, for your safety and the preservation of your baseplate, be sure to use a replacement bolt of the same grade (In most cases it will be Grade 5, please reference the parts list above). Replacement parts may be ordered through your nearest Blue Ox® Dealer or Distributor, or call our 24/7 Customer Care Team at (402)385-3051.

BX2711 2005 Kia Spectra Installation Instructions

Attachment Tabs:

Motorhome mount tow bars are recommended for use with this baseplate. Due to the design of the removable tabs, the RangeFinder II, Adventurer, and Ambassador tow bars can not be used. The Acclaim tow bar may be used, but will not fold and store on the front of the vehicle. Adapters, except the BX8833 and BX88151, can not be used with this baseplate.

Instructions:

The fascia and plastic cover are removed and reinstalled for the baseplate installation. Drilling is required.

Trimming of the frame rail is required.

The dimensional variations between otherwise identical vehicles can be considerable. While the baseplate was designed for easy installation, it may be necessary to tailor the baseplate slightly to compensate for auto manufacturer's tolerances. These minor adjustments may include filing a hole slightly, bending electrical rods, and/ or bending end plates.

The Bx8869 Bulb and Socket Wiring Kit is recommended for this vehicle.



1. From the plastic cover on the top edge of the fascia, remove six Phillips pushpins from the driver's side. Set pushpins aside to reinstall later.



2. From the plastic cover on the top edge of the fascia, remove five Phillips pushpins from the passenger's side. Remove the black plastic. Set pushpins and plastic aside to reinstall later.



3. Directly below the plastic cover just removed, use a 10MM socket to remove two metric bolts from the top of the metal bumper bracket. Set bolts aside to reinstall later.

BX2711

2005 Kia Spectra

Installation Instructions

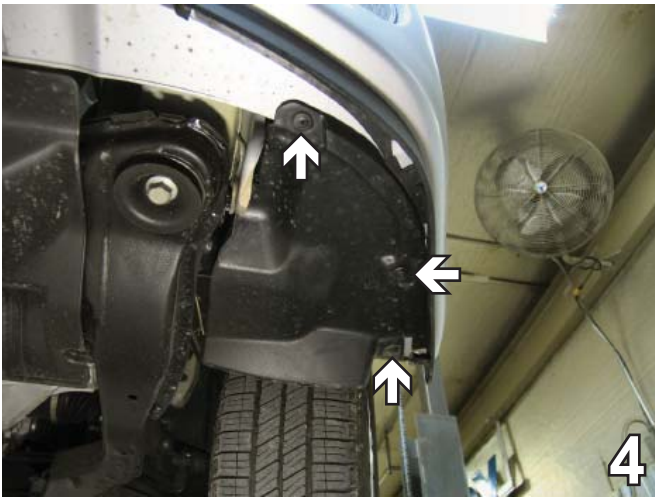

4. On the bottom corner of the fascia, just forward of the front tire, remove three pushpins. Do this to both sides of the vehicle. Set pushpins aside to reinstall later.

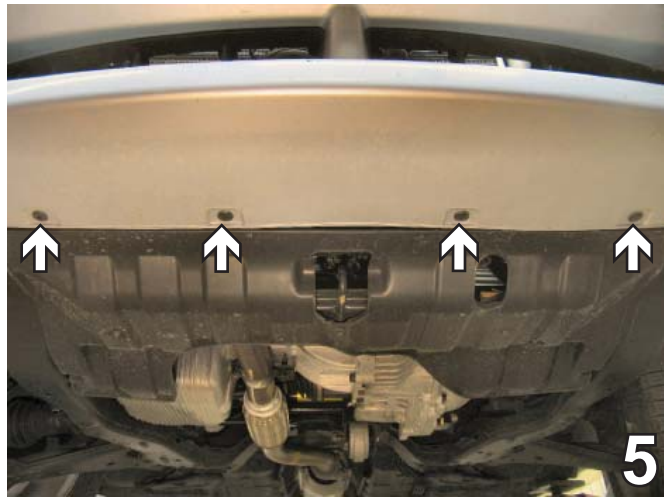

5. Remove four pushpins found on the bottom of the fascia. Set pushpins aside to reinstall later.

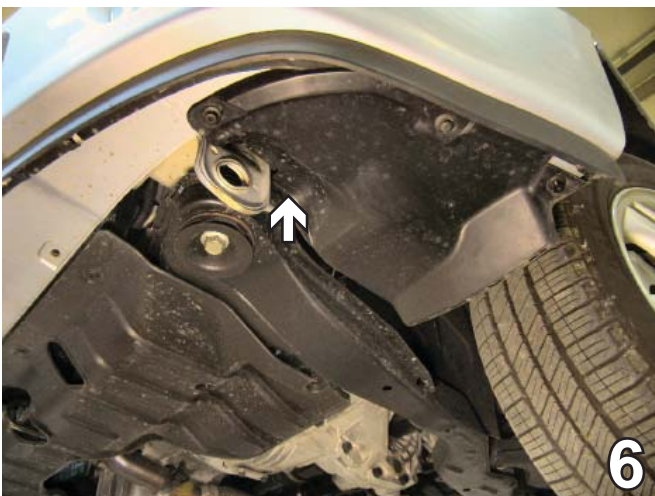

6. Remove the pushpin near the tie down bracket at the front of the wheel well. Do this to both sides of the vehicle. Set pushpins aside to reinstall later.

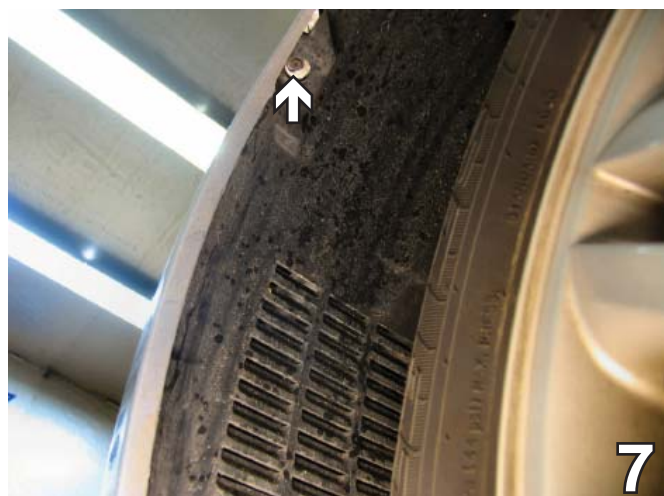

7. Using a Phillips screwdriver, remove the metric bolt just forward of the front tire on the wheel well. Do this to both sides of the vehicle. Set pushpins aside to reinstall later. Pull fascia forward to remove. Carefully set fascia aside to reinstall later.

BX2711

2005 Kia Spectra

Installation Instructions

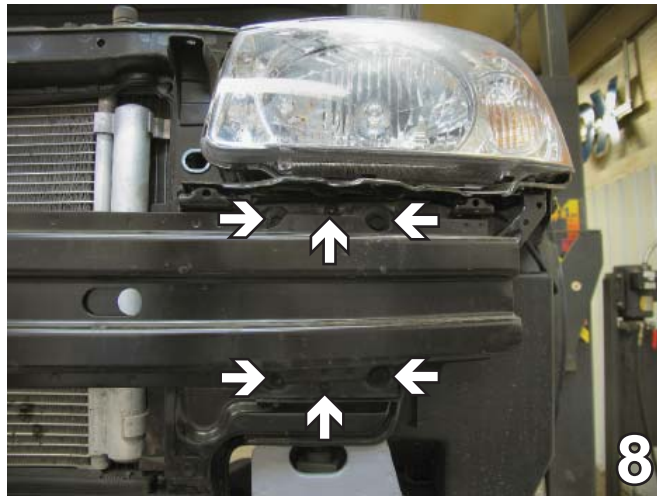

8. Remove six metric bolts securing the metal bumper. Between the headlight and the bumper are three bolts. Using a 12MM socket, remove the two larger metric bolts. Using a 10MM socket, remove the smaller metric bolt. Repeat this for the three metric bolts found below the metal bumper. Do this to both sides of the vehicle. Set bolts aside to reinstall later. Pull the bumper forward to remove. Set the bumper aside to reinstall later.

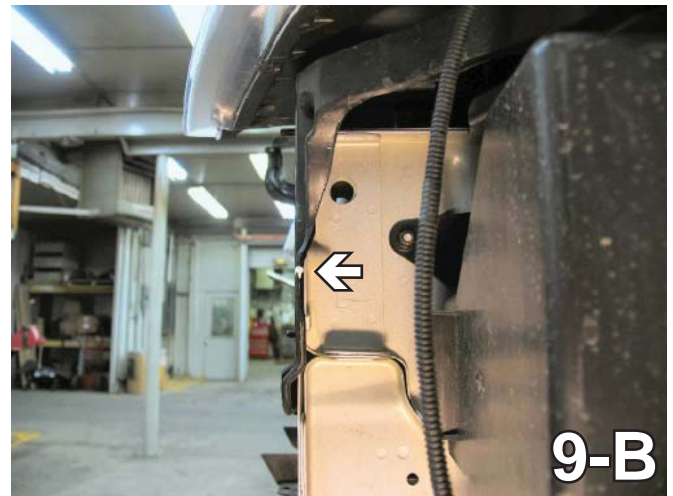

9. On the side of the frame, bend the tab down flush with the frame side, using the hammer. Do this to both sides of the vehicle. Mark an area to be trimmed on the bumper bracket on the frame end. Begin marking on the side of the bracket level with the bottom of the dimple found on the side of the frame (see the arrow in Photo 9-B). On the front of the side bumper bracket make a mark approximately 1 1/2" in toward the radiator to be flush with the side of the frame rail just behind the bumper bracket. This top horizontal cut is approximately 4 3/4" from the top of the bracket, and the lower horizontal cut is 8 3/4" from the top of the bracket. Mark a vertical line on the front of the bracket, flush with the side of the frame rail. Do this to both sides of the vehicle.

BX2711 2005 Kia Spectra Installation Instructions

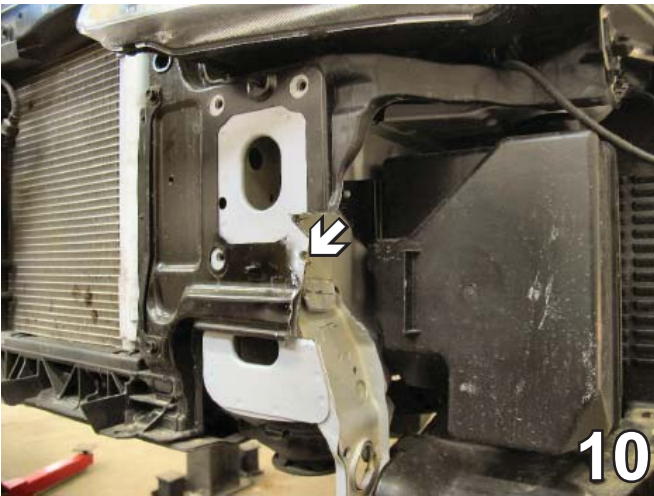

10. Begin removing this area with the reciprocating saw by first cutting the two horizontal cuts into the bumper bracket. It will take several vertical cuts to remove the marked area and make it flush with the frame. Do this to both sides of the vehicle.



11. The newly cut area should be treated with spray paint as an anti-corrosive measure.

****BE SURE TO USE LOCTITE® RED ON ALL BOLTS BEFORE TIGHTENING. TIGHTEN ALL BOLTS ACCORDING TO THE TORQUE CHART ON PAGE 1 OF THESE INSTRUCTIONS OR ON PAGE 3 OF THE BASEPLATE TOWING GENERAL INSTRUCTIONS.**

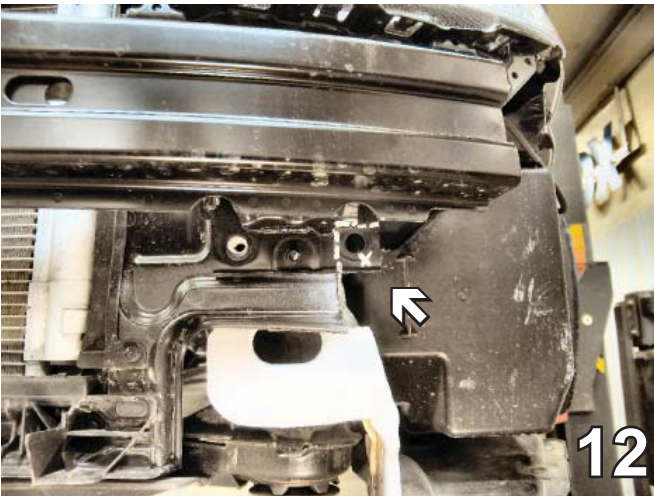

12. Reinstall metal bumper. Only one bolt per side needs to be reinstalled because the bumper is removed again shortly. On the lower bumper bracket, mark a square area around the bolt hole closest to the outermost bumper bracket edge. Note that the vertical cut will be flush with the side of the frame. Do this to both sides of the vehicle. Remove the metric bolts securing the metal bumper. Pull bumper forward to remove. With the metal bumper on a stable surface, use the reciprocating saw to cut the marked area around the bolt hole. Doing this prepares the area for baseplate installation.

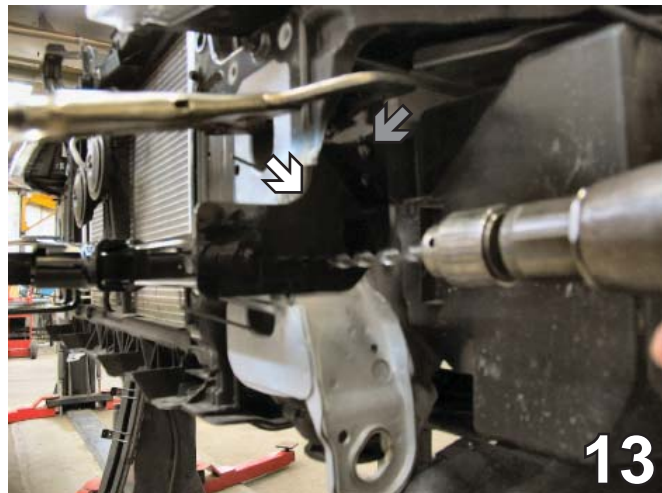

13. Guide baseplate so that its curved area, as indicated by the white arrow in the photo above, hugs the ribbed area of the frame. Position the baseplate until one of its bolt holes aligns with a pre-existing nut on the frame, as indicated by the grey arrow in the photo above. Do this to both sides of the vehicle. Using a large Vise grip, clamp the baseplate into place.

BX2711

2005 Kia Spectra

Installation Instructions

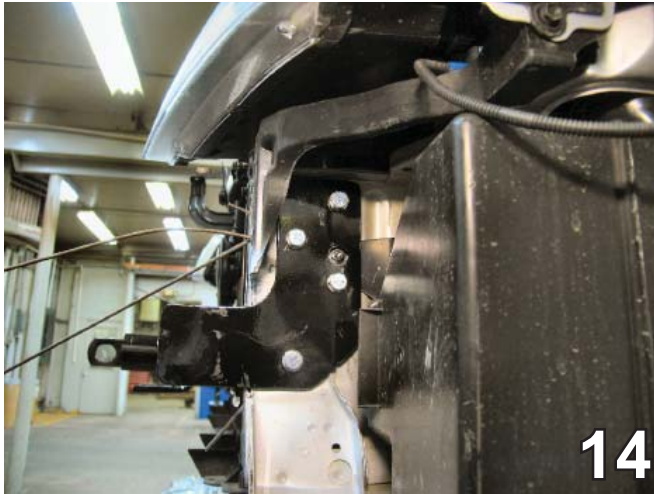

14. Using the baseplate as a template, drill into the frame through the four remaining baseplate holes using a 13/32" drill bit. Guide the 3/8-16 nut plates through openings in the frame and frame rail openings to align with the baseplate holes. Insert 3/8-16 x 1 1/2 hex bolts with 3/8" lock washers and tighten to nut plates. Do this to both sides of the vehicle.

****BE SURE TO USE LOCTITE® RED ON ALL BOLTS BEFORE TIGHTENING. TIGHTEN ALL BOLTS ACCORDING TO THE TORQUE CHART ON PAGE 1 OF THESE INSTRUCTIONS OR ON PAGE 3 OF THE BASEPLATE TOWING GENERAL INSTRUCTIONS.**

16. Reinstall the fascia and the plastic cover, inserting all screws, pushpins, and bolts. Installation of baseplate is complete.

Install the tow bar and safety cables according to the instructions when demonstrating this to the customer. Be sure to include all the contents and packages.

Do **NOT** substitute other devices if the tow bar pins and clips are misplaced.



15. Reinstall the metal bumper. **NOTE:** It is recommended to slide one side of the bumper in first and then make adjustments so the other side can slide under the headlight assembly. It may be necessary to loosen the metric bolts of the headlight assembly in order to guide the bumper under the headlight assembly.

Be sure that ALL electrical connections are plugged in properly and functioning BEFORE Installing the fascia.

DEALER or INSTALLER:
Be certain the user receives the instruction sheets for their products.

BX2711

2005 Kia Spectra

Installation Instructions



The BX8869 Bulb & Socket Kit is recommended for this vehicle.



Without removable tabs installed.



With removable tabs installed.

Customer Service Commitment

Blue Ox® is focused on providing exemplary customer service, as observed in our mission statement and guiding principles. In accordance with this objective, Blue Ox® is proud to provide services such as repairs and general maintenance of Blue Ox® products at over 150 RV Rallies. Look for our Destination America or Blue Ox® Racing service crews at the next rally or NASCAR race that you attend. If you were not present at the time of service, you will find an informative, personalized note explaining any services that may have been performed to your Blue Ox® products.

Blue Ox® also offers educational seminars at rallies and through our Parks and Resort teams. In addition, Blue Ox® customers visiting our factory may take advantage of the well-equipped Blue Ox® RV park at no charge to you, our valued and appreciated customer.



© 2006 Blue Ox
One Mill Road, Industrial Park
Pender, Nebraska 68047
Phone: (402) 385-3051
Toll Free: (888) 425-5382
Fax: (402) 385-3360
www.blueox.us